

12 11 10 9 8 7 6 5 4 3 2 1

H  
G  
F  
E  
D  
C  
B  
A

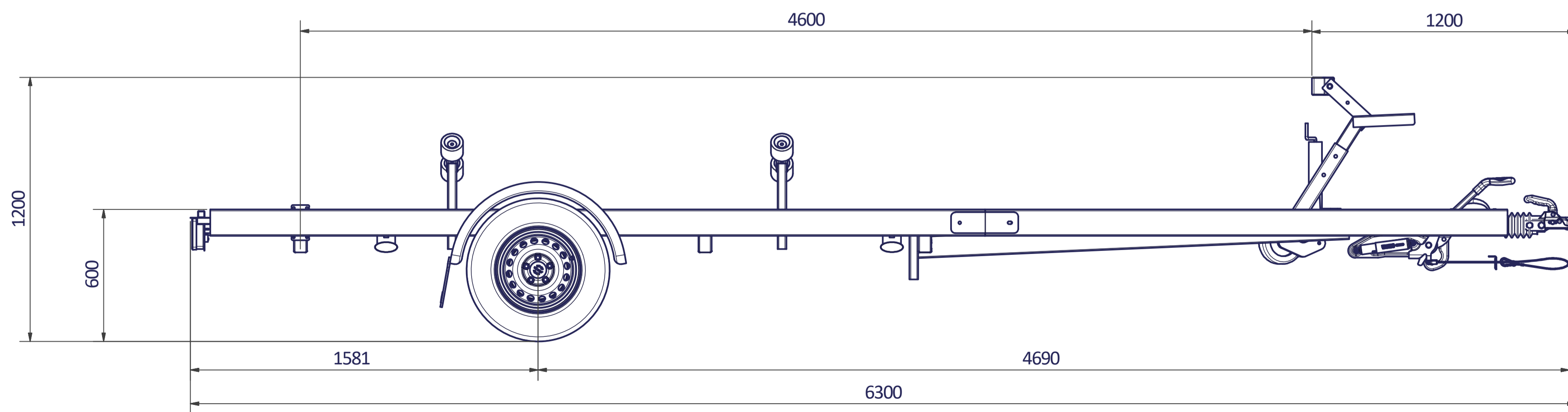
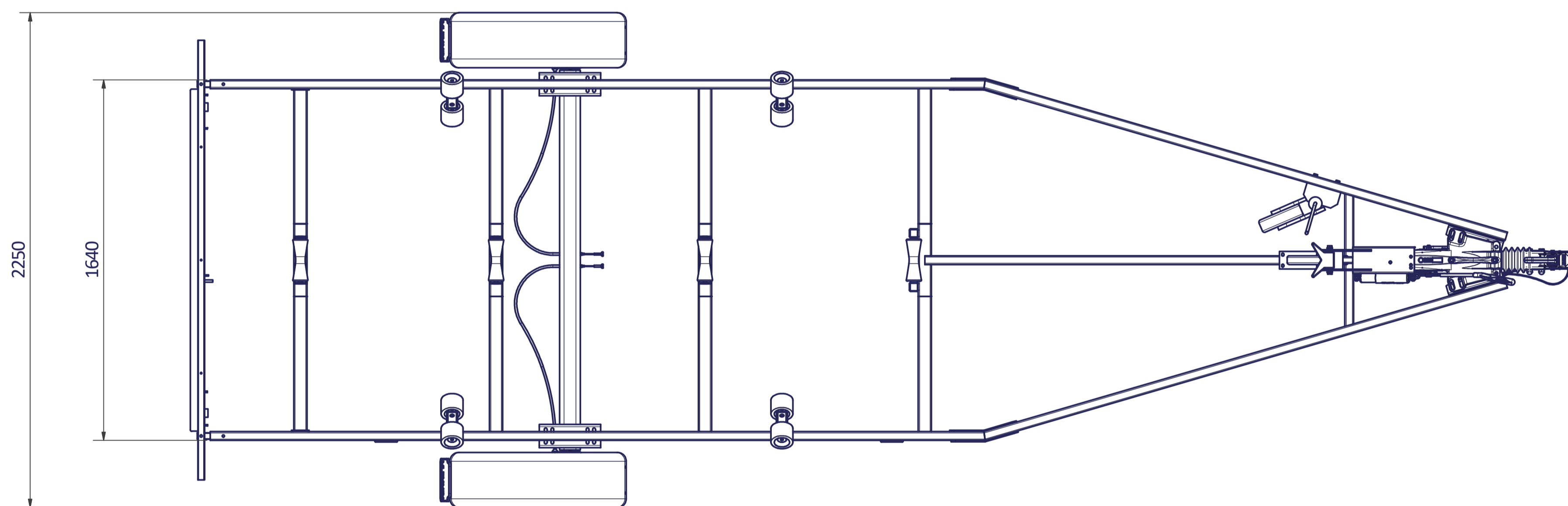
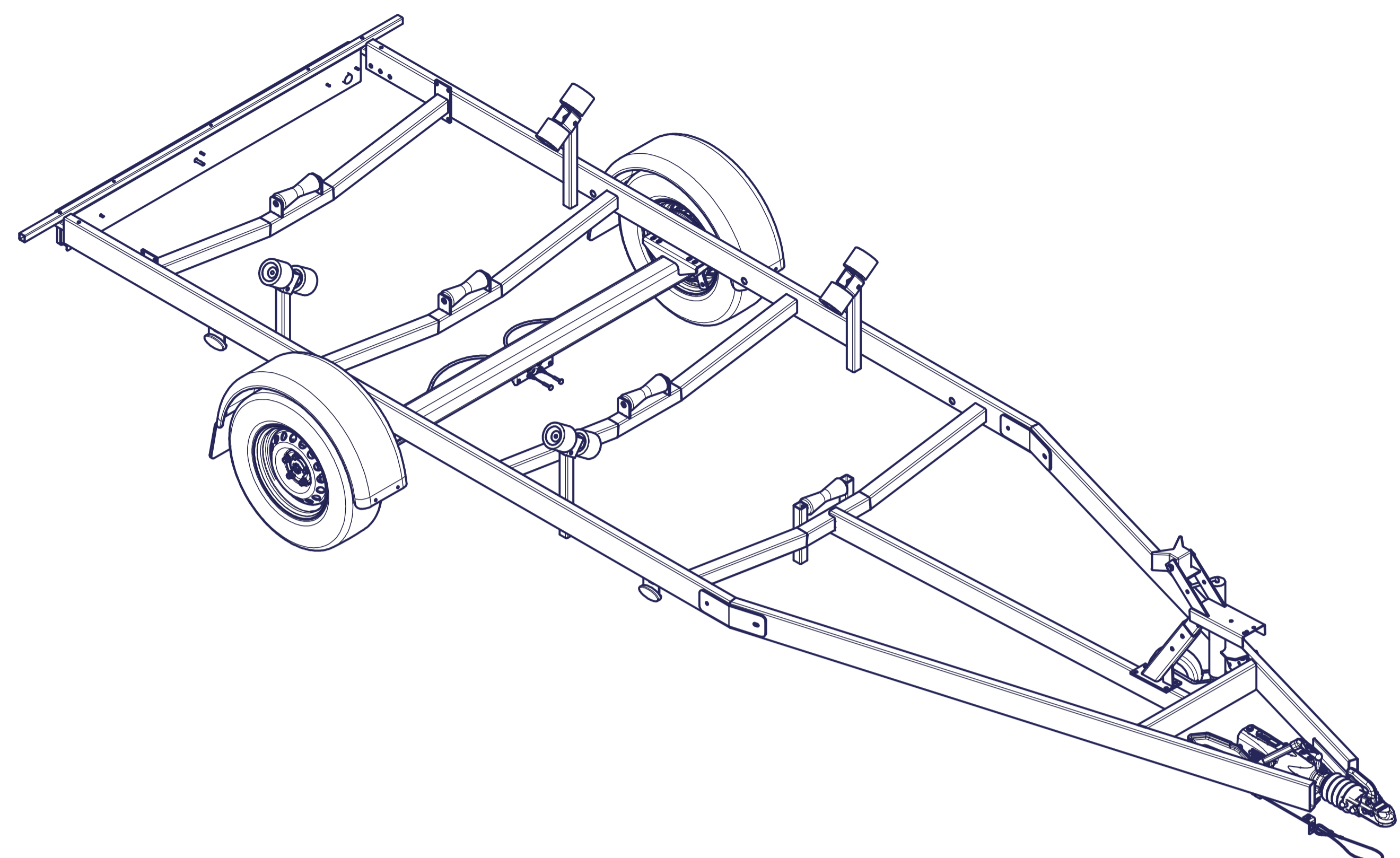
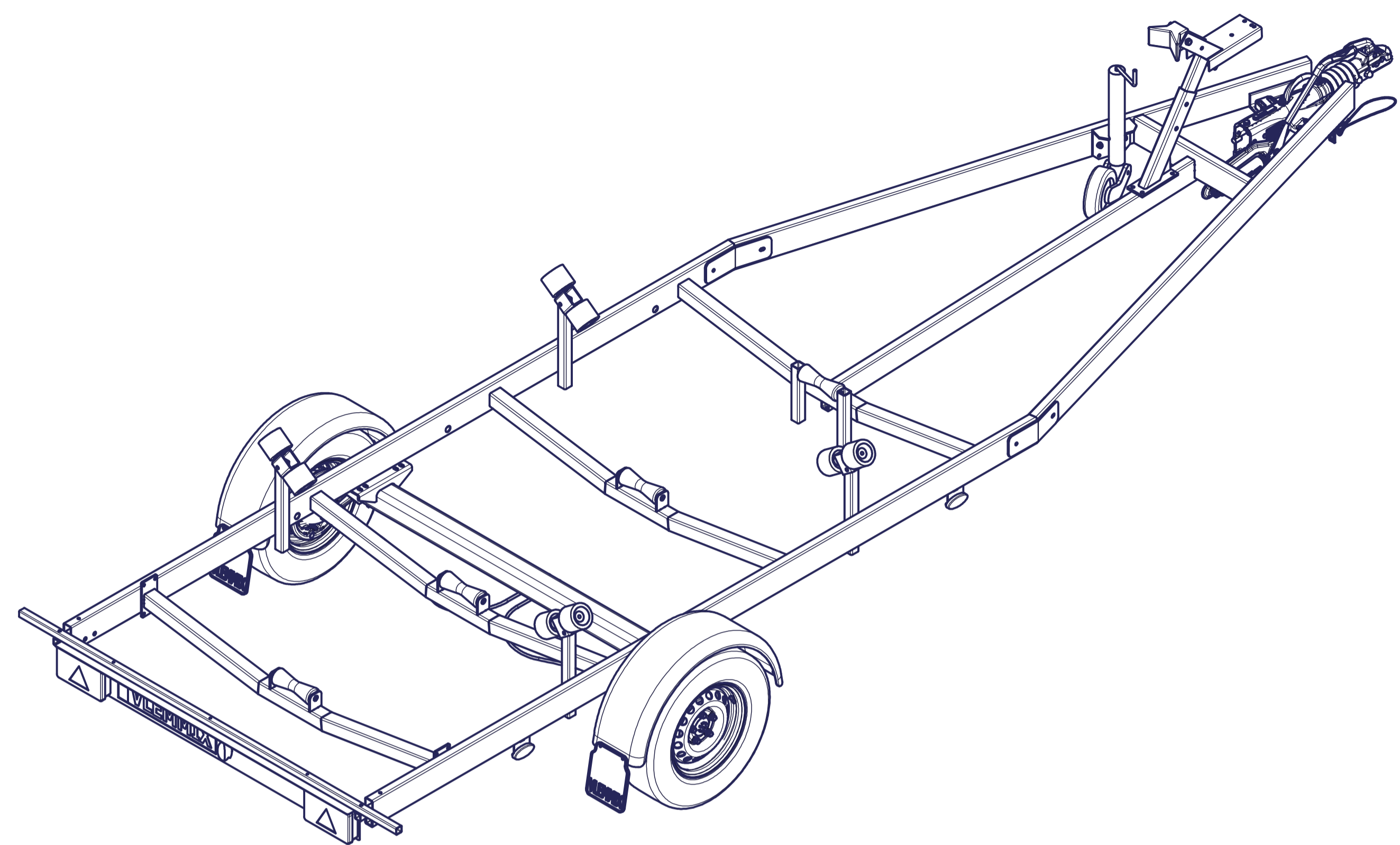

12 11 10 9 8 7 6 5 4 3 2 1

# BOOTTRAILER 630

Surface treatment:			
QTY:	© VLEMMIX AANHANGWAGENS This drawing and its contents may not be made accessible and/or duplicated for others without permission. All rights reserved.		
TOLERANCE:	UNIT:	DRAWN BY:	J.H.
ISO 2768-MK	mm	DATE:	19-5-2020
PROJECT/DRAWING NO.:		3374_BOOT TRAILER	
SCALE:	DESCRIPTION:	SHEET:	8
A1	1:15	SHEETS:	8

A1

1:15

SHEET: 8  
SHEETS: 8